

Compact drive with specific attachments for a wide spectrum of applications

Air Pen Drive

Instructions for Use



Table of Contents

Introduction	General Information	3
	Explanation of Symbols	5

Air Pen Drive System	Air Pen Drive	6
	Angular Coupling (05.001.085)	8
	Hand Switch (05.001.082)	9
	Foot Switch (05.001.081)	10

Attachments	General Information	11
	Drill Attachments	12
	Screw Attachments	14
	Kirschner Wire Attachment	15
	Saw Attachments	16
	Burr Attachments	18
	Adapter for Intra Coupling	20
	Perforators	21
	Craniotome Attachment	23

Cutting Tools	General Information	24
----------------------	---------------------	----

Care and Maintenance	General Information	25
	Cleaning and Disinfection	26
	• Preparation Prior to Reprocessing	26
	• Manual Cleaning Instructions	27
	• Automated Cleaning Instructions with Manual Pre-cleaning	29
	Maintenance and Lubrication	33
	Function Control	36
	Packaging, Sterilization and Storage	37
	Repairs and Technical Service	38
	Disposal	39
Troubleshooting		40
System Specifications		42
Ordering Information		47

Introduction

General Information

Intended use

The Air Pen Drive is an air-driven system to be used for treatment in general traumatology, as well as for surgeries in the areas of the hand, foot, spine, maxillofacial and neurosurgery.

Safety instructions

The surgeon has to evaluate if the machine is suitable for an application, based on power limitation of the machine, attachment and cutting tool regarding bone strength/anatomical situation as well as handling of the machine, attachment and cutting tool regarding bone size. In addition, the contraindications of the implant have to be respected. Please refer to the corresponding "Synthes Implant Instructions for Use" of the implant system used.

The Air Pen Drive System is only to be used for patient treatment after careful consultation of the instructions for use. It is recommended that an alternative system is available to use during application, as technical problems can never be completely ruled out.

The Air Pen Drive System is designed for use by physicians and trained medical personnel.

DO NOT use any component if damage is apparent.

DO NOT use this equipment in presence of oxygen, nitrous oxide or a mixture consisting of flammable anesthetic and air. Never use oxygen to run air-powered systems (danger of explosion!); only use compressed air or compressed nitrogen.

To ensure proper operation of the tool, use only Synthes original accessories.

Recommended operating pressure: 6–8 bar (see also chapter System Specification)

Only use original Synthes hoses for compressed air.

Before first and every use, power tools and their accessories/attachments have to run through the complete reprocessing procedure. Protective covers and foils must be fully removed before sterilization.

Check instruments for correct adjustment and functioning prior to every use.

Always wear personal protective equipment (PPE) including safety goggles when handling with the Air Pen Drive.

To prevent overheating, always respect the duty cycles for each attachment listed on page 42.

For the tool to function properly, Synthes recommends that it is cleaned and serviced after each use in accordance with the process recommended in the chapter "Care and Maintenance". Compliance with these specifications can considerably extend the service life of the tool. Only use Synthes Maintenance Oil for EPD/APD, 40 ml or Synthes Maintenance Spray 400 ml to lubricate the tool.

Efficiently working cutting tools are the basis for successful surgery. Therefore, it is mandatory to check used cutting tools after every use for wear and/or damage and to replace them if necessary. We recommend using new Synthes cutting tools for every surgery.

Cutting tools must be cooled with irrigation liquid to prevent heat necrosis.

The user of the product is responsible for proper use of the equipment during surgery.

If the Air Pen Drive System is used in conjunction with an implant system make sure to consult the corresponding "Synthes Implant Instructions for Use".

This system requires regular maintenance service, at least once a year, in order to maintain its functionality. This service has to be performed by the original manufacturer or an authorized site.

Unusual Transmissible Pathogens

Surgical patients identified as at-risk for Creutzfeldt-Jakob disease (CJD) and related infections should be treated with single-use instruments. Dispose of instruments used or suspected of use on a patient with CJD after surgery and/or follow current national recommendations.

Precautions:

- **Never use oxygen to run air-powered systems (danger of explosion!); only use compressed air or compressed nitrogen.**
- **To avoid injuries, the locking mechanism of the tool has to be activated before every manipulation and before placing the tool back down, i.e. the mode switch has to be in the LOCK position (🔒).**
- **Should the machine drop on the floor and have visible defects, do not use it anymore and send it to the Synthes service center.**
- **If a product drops on the floor, fragments may split off. This represents danger for the patient and user as:**
 - **these fragments may be sharp.**
 - **unsterile fragments may enter the sterile field or hit the patient.**

Accessories/Scope of delivery

The main components in the APD System are the hand-piece, Hand Switch, Foot Switch, Air Hose as well as attachments and accessories. An overview of all components belonging to the Air Pen Drive System can be found in the chapter "Ordering Information".

For using the Air Pen Drive System the following components are a must:

- Air Pen Drive 60,000 rpm (05.001.080)
- Hand Switch (05.001.082) or Foot Switch (05.001.081, also a Double Air Hose from Synthes is necessary to connect the Foot Switch e.g. 519.510)
- Double Air Hose, for Air Pen Drive (05.001.083 or 05.001.084)
- At least one attachment belonging to the system and cutting tool fitting to the attachment

For an optimal function of the system only Synthes cutting tools shall be used.

Synthes recommends the use of the specifically designed Synthes Vario Cases and of the specifically designed Washing Basket (68.001.800) to sterilize and store the system.

For care and maintenance special tools are available, such as cleaning brushes, Synthes Maintenance Oil for EPD and APD (05.001.095), Maintenance Spray (05.001.098) and Maintenance Unit (05.001.099).

No oils from other manufacturers may be used. Only Synthes Maintenance Oil for EPD/APD, 40 ml or Synthes Maintenance Spray 400 ml may be used.

Lubricants with other compositions can cause jamming, can have a toxic effect or can have a negative impact on the sterilization results. Only lubricate the power tool and the attachments when clean.

Locating of the instrument or fragments of instruments

Synthes instruments are designed and manufactured to perform within the scope of their intended use. However, if a Power Tool or accessory/attachment breaks during use, a visual inspection or a medical image device (e.g. CT, Radiation Devices, etc.) can aid in locating the fragments and/or components of the instrument.

Storage and Transportation

Only use the original packaging for dispatch and transport. If the packing material is no longer available, please contact the Synthes office. For storage and transport environmental conditions, see page 43.





















Warranty/Liability

The warranty for the tools and accessories does not cover damage of any kind resulting from wear, improper use, improper reprocessing and maintenance, damaged seal, use of non Synthes cutting tools and lubricants or improper storage and transport.

The manufacturer excludes liability for damage resulting from improper use, neglected or unauthorized maintenance or servicing of the tool.

For further information on the warranty please contact your local Synthes office.

Explanation of Symbols

	Caution		Do not reuse
	Read the provided instructions for use before operating the device.		Products intended for single use must not be reused.
	Do not immerse device in liquids.		Reuse or reprocessing (e.g. cleaning and resterilization) may compromise the structural integrity of the device and/or lead to device failure, which may result in patient injury, illness or death. Furthermore, reuse or reprocessing of single use devices may create a risk of contamination e.g. due to the transmission of infectious material from one patient to another. This could result in the injury or death of the patient or user.
	The device meets the requirements of directive 93/42/EEC for medical devices. It is authorized by an independent notified body for which it bears the CE symbol.		
	Locked symbol. Drive Unit is off for safety.		
	Legal manufacturer		Synthes does not recommend reprocessing contaminated products. Any Synthes product that has been contaminated by blood, tissue and/or bodily fluids/matter should never be used again and should be handled according to hospital protocol. Even though they may appear undamaged, the products may have small defects and internal stress patterns that may cause material fatigue.
	Manufacturing date		
	Non sterile		
	Temperature limitations		Reference number
	Relative humidity		Lot number
	Atmospheric pressure		Serial number
	Do not use if package is damaged.		Packaging unit ISO 7000-2794 (2009-02)
			Expiration date
			Segurança
			INMETRO Ord. 350 certified

Air Pen Drive System



Air Pen Drive

Mounting the air hose on the handpiece

The Air Hose (05.001.083 or 05.001.084) is coupled by fitting the pins on the hose coupling into the grooves on the coupling for hoses on the handpiece and turning the hose coupling clockwise. Attach the other end of the air hose to the compressed air or nitrogen source or to the Foot Switch (05.001.081, see page 10). Ensure that the coupling geometry of the air hose is compatible with the geometry of the wall coupling. If the operating room does not have an exhaust air system then use the Air Diffusor (519.950) to diffuse the air. The Air Diffusor is connected between the source and the air hose. To disconnect the air hose simply turn the hose coupling piece counterclockwise and pull it off the handpiece. Remove the air hose from the compressed air or nitrogen source or from the Foot Switch.





Adjusting the handpiece

- 1 Adjustment sleeve
- 2 Release sleeve for attachment
- 3 Coupling for hoses
- 4 LOCK position 
- 5 Hand Switch position 
- 6 Foot Switch position 
- 7 Lock slide for adjustment sleeve



Adjustment sleeve

To avoid an unintentional change of the operating mode the lock slide for adjustment sleeve 7 locks the adjustment sleeve automatically. To be able to move the adjustment sleeve the lock slide has to be pushed backwards. After having reached the desired position release the lock slide and the adjustment sleeve is locked in the desired position.

By turning the adjustment sleeve into the hand switch position , the handpiece can be used with the Hand Switch. In the foot switch position  only the Foot Switch shall be used! If the foot switch position  is set and no Foot Switch is attached the handpiece will run with full speed.

Either a Hand Switch or a Foot Switch can be used for speed control.

The LOCK position  is used for safety switch-off when changing attachments and tools. This prevents accidental start-up of the unit while performing these activities.

For instructions on mounting the attachments see the chapter "Attachments".

Precaution: The air hoses have to be connected properly and should never be squeezed with sharp objects or obstructed by any loads. Non-respect might lead to bursting of the outer hose!

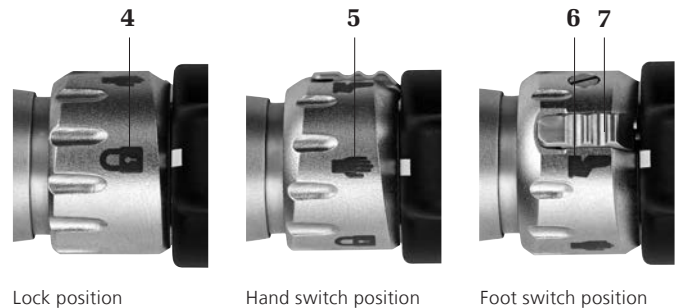

Angular Coupling (05.001.085)

The Angular Coupling (05.001.085) can be connected to the Air Pen Drive (05.001.080) and the Air Hose (05.001.083 or 05.001.084) and is used to guide the air hose away from the handpiece in a 45° angle. It allows 360° rotation.



Mounting the Angular Coupling

The Angular Coupling is coupled to the handpiece by fitting the pins into the grooves on the coupling for hoses on the handpiece and turning the Angular Coupling clockwise. The Air Hose is then connected to the Angular Coupling by fitting the pins on the Air Hose coupling into the grooves of the Angular Coupling by turning it clockwise. To disassemble it turn the parts counter-clockwise and pull the Air Hose off the Angular Coupling, and then the Angular Coupling off the handpiece.

Hand Switch (05.001.082)

- 1 Positioning arrow
- 2 Pull-out finger rest
- 3 Positioning arrow
- 4 Guide groove
- 5 Locking switch

Mounting the Hand Switch on the Handpiece

Position the Hand Switch on the handpiece so that both positioning arrows **1** of the Hand Switch cover the positioning arrows **3** over the guide grooves **4** of the pen. Then press downward vertically until the Hand Switch clicks into position.



Removing

To remove the Hand Switch, grasp the lever and pull it away upwards.

Operation

The adjustment sleeve on the pen must be set on the hand switch position for working with the Hand Switch.

The length of the Hand Switch can be individually adjusted with the pull-out finger rest **2**. The speed can be continuously adjusted by operating the Hand Switch. The Hand Switch can be deactivated (LOCK position) or activated (ON position) with the locking switch **5**.



Precaution: Do not set the adjustment sleeve in the Foot Switch position, if the system is used with the Hand Switch only and no Foot Switch is connected! This will make the pen run constantly and can be very dangerous for patient and OR staff.

Air Pen Drive System

Foot Switch (05.001.081)

- 1 Pedal
- 2 Irrigation ON/OFF button*
- 3 Plug for Double Air Hose
- 4 Plug for Irrigation Control Unit*
- 5 Plug for Air Pen Drive Hose

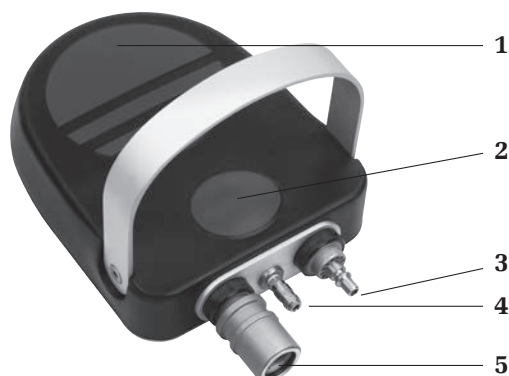

Connecting the Foot Switch

Connect a Double Air Hose (519.510, 519.530, 519.550 for System Synthes; 519.610, 519.630, 519.650 for System Dräger; 519.511, 519.531 for System BOC/Schrader) to the male plug for the Double Air Hose on the Foot Switch **3** and connect it to the air outlet socket. Then connect the Double Air Hose for Air Pen Drive (05.001.083 or 05.001.084) to the female plug for Double Air Hoses **5**. To remove the air hoses simply slide the female hose-coupling pieces in direction of the arrow.

Operation

The adjustment sleeve on the pen must be set on the Foot Switch position for working with the Foot Switch.

The speed can be continuously adjusted with the pedal.

Precaution: Never keep the adjustment sleeve in the Foot Switch position , if no Foot Switch is connected! This will make the pen run constantly and can be very dangerous for patient and OR staff.

*The Irrigation Control Unit is no longer available

General Information

Mounting the attachments on the handpiece

The attachments can be connected in 8 different positions (45° increments). To mount, turn the release sleeve for the attachments clockwise (see arrow on the release sleeve) until it engages. The release sleeve protrudes slightly from the black section of the handpiece towards the front. Insert the attachment into the attachment coupling from the front and press it lightly against the handpiece. The attachment automatically engages. If the release sleeve accidentally closes, turn the attachment clockwise while applying slight pressure against the handpiece until it engages without holding the release sleeve in place, or repeat the entire connection process. Check secure holding of the attachment on the handpiece by pulling on the attachment.



Release sleeve

Removing the attachments from the handpiece

Turn the release sleeve for attachments (see page 6) clockwise until it disengages. Hold the attachment upward while doing so. Then remove the attachment.

Attachments and accessories

For easier change of burrs, without having the Burr Attachment or Craniotome Attachment connected to the handpiece, the Handhold for Change of Instruments (05.001.074) can be used.



Warranty: Only use Synthes saw blades, burrs and rasps while working with the Air Pen Drive attachments. The use of other tools voids the device warranty.

Drill Attachments

Drill Attachments (05.001.030–05.001.032, 05.001.044)

Speed: approx. 1,800 rpm at 6.5 bar

The system includes straight Drill Attachments with Mini Quick, J-Latch and AO/ASIF Coupling and a 45° cannulated AO/ASIF Drill Attachment.

The 45° Drill Attachment with AO/ASIF Coupling (05.001.044) has a cannulation of 1.6 mm, which permits the use of this attachment for drilling and reaming over Kirschner Wire (e.g. for cannulated screws and for cup and cone technique).

Mounting and removing tools

Lock unit. Pull back the release sleeve and insert/remove the tool.



1 Release sleeve

Drill Attachment 45°, cannulated, with Jacobs Chuck (05.001.120)

Speed: approx. 1,800 rpm at 6.5 bar

Clamping range: 0.5 mm–4.7 mm

The cannulation of 1.6 mm permits the use of this attachment for drilling and reaming over Kirschner Wire (e.g. for cannulated screws and for cup & cone technique).

Mounting and removing tools

Lock unit. Open the chuck with the key provided (310.932) or by hand by turning the two moving parts clockwise with respect to each other. Insert/remove the tool. Close the chuck by turning the moving parts counterclockwise and tighten it by turning the key clockwise.



1 Release sleeve



**Drill Attachment 90°, short (05.001.035)
and long (05.001.036) with Mini Quick Coupling**

Speed: approx. 1,800 rpm at 6.5 bar

Due to its very small angled head, the 90° Drill Attachments enable good visibility during operations with narrow access (e.g. intraoral, shoulder etc.).

Mounting and removing tools

Lock unit. Move the slide **1** to the side following the arrow on the slide and insert/remove the tool. To secure the tool, push the slide back again.

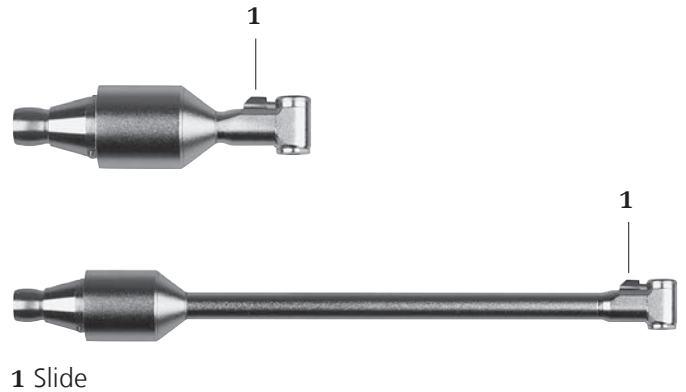

Oscillating Drill Attachment (05.001.033)

Frequency: approx. 3,200 osc./min at 6.5 bar

The oscillating drilling movement of the Oscillating Drill Attachment prevents tissue and nerves from wrapping around the drill. This can considerably improve the operating results.

Mounting and removing tools

Cutting tools with a Mini Quick Coupling can be clamped with the Oscillating Drill Attachment. To do this, lock the unit, pull back the release sleeve **1** and insert/remove the tool.



Screw Attachments

Screw Attachments

(05.001.028, 05.001.029, 05.001.034)

Speed: approx. 400 rpm at 6.5 bar

The system includes screw attachments with AO/ASIF coupling, hexagonal and mini quick coupling.

Mounting and removing tools

Lock unit. Pull back the release sleeve and insert/remove the tool.

Precautions:

- Only use the attachment with 6.5 bar to avoid higher speed than 400 rpm.
- Always use the appropriate Torque Limiting device while inserting locking screws into a locking plate.
- The APD contains no reverse mode for removing screws.



1 Release sleeve

Kirschner Wire Attachment

Kirschner Wire Attachment (05.001.037)

Speed: approx. 2,700 rpm at 6.5 bar

With the Kirschner Wire Attachment, Kirschner Wires of any length with a diameter of 0.6–1.6 mm can be tensioned. The tensioning lever **1** can be rotated by 300°, permitting individual adjustment (suitable for left and right-handed users).

Mounting and removing Kirschner Wires

Lock unit. To insert and remove Kirschner Wires, press the tensioning lever **1**. After the lever is released, the Kirschner Wire is automatically tensioned. To re-grasp, press the tensioning lever, pull back the unit along the Kirschner Wire and then release the tensioning lever again.

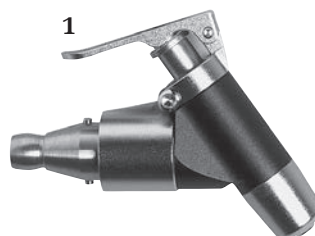

1 Tensioning lever

Saw Attachments

Working with saw attachments

Allow the unit to start up before placing it on the bone. Avoid heavy pressure on the saw blade so that the cutting process is not slowed and the saw teeth do not bind up in the bone. The best sawing performance is achieved by moving the unit slightly to and fro on the plane of the saw blade. Imprecise cuts indicate worn saw blades, excessive pressure or jamming of the saw blade due to tilting.

Information on handling saw blades

Synthes recommends using a new saw blade for each surgery, as only then can it be ensured that the saw blade is always optimally sharpened and clean. Used saw blades present the following risks:

- Necrosis due to excess heat
- Infections due to residues
- Longer cutting time due to reduced sawing performance

Sagittal Saw Attachment (05.001.039)

Frequency: approx. 22,000 osc./min at 6.5 bar

Sagittal Saw Attachment, centered (05.001.183)

Frequency: approx. 22,000 osc./min at 6.5 bar

Sagittal Saw Attachment 90° (05.001.182)

Frequency: approx. 16,000 osc./min at 6.5 bar

Changing saw blades

1. Lock unit.
2. Press the clamping button **1**, lift the saw blade and remove it.
3. Push a new saw blade into the saw blade coupling and move it into the desired position. The saw blade can be locked in 5 different positions (05.001.039 and 05.001.183) and in 8 different positions (05.001.182) for optimum positioning (45° increments).
4. Release the clamping button.

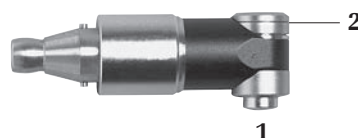

- 1** Clamping button for saw blades
- 2** Mounting opening for saw blades

Oscillating Saw Attachment (05.001.038)

Frequency: 16,000 osc./min at 6.5 bar

The Oscillating Saw Attachment is used with Synthes crescentic and 105° angled saw blades.

Changing saw blades

1. Lock unit.
2. Pull back the release sleeve for saw blades **1** and remove the saw blades from the mounting opening **2**.
3. Push a new saw blade into the mounting opening **2** and move it into the desired position.
4. Release the release sleeve for saw blades.

Mounting and removing the Guide for Kirschner Wires (05.001.121)

Secure the Guide for Kirschner Wires on the Oscillating Saw, by pushing the Guide as far as possible over the attachment from the front, so that it engages in the shape of the Oscillating Saw.

Then mount the attachment on the handpiece.

Note: No irrigation nozzle is available for the oscillating saw attachment.

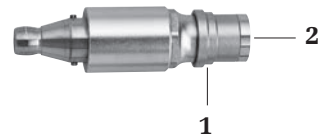

- 1** Release sleeve for saw blades
2 Mounting opening for saw blades

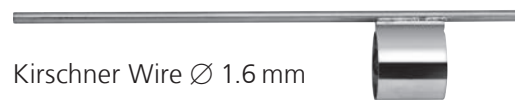

Kirschner Wire Ø 1.6 mm

Reciprocating Saw Attachment (05.001.040)

Frequency: 18,000 osc./min at 6.5 bar

Stroke: 2.5 mm

Both Synthes reciprocating saw blades and Synthes rasps can be used with the Reciprocating Saw Attachment.

Replacing saw blades

1. Lock unit.
2. Turn the release sleeve for saw blades **1** clockwise until it engages and remove the saw blade.
3. Insert a new saw blade until slight resistance can be felt. Turn the saw blade with slight pressure until it automatically engages.

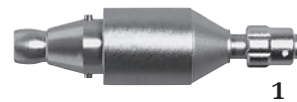

- 1** Release sleeve for saw blades

Burr Attachments

Burr Attachments

(05.001.045–05.001.050, 05.001.055, 05.001.063)

Gear ratio: 1:1

The system includes straight and angled Burr Attachments in 3 lengths each (S, M, L). The related burrs are also marked with S, M and L. Angled XL and XXL Burr Attachments are available; for these attachments the L burrs shall be used.

Changing burrs

1. Lock unit.
2. Turn the release sleeve for burrs **1** until it engages in the UNLOCK position and remove the tool.
3. Insert the new tool as far as possible, turn it slightly until it locks in place and then turn the release sleeve for burrs into the LOCK position until it engages. The burr is correctly clamped when the marking S, M or L on the burr shank is no longer visible.

Information on handling burrs

- Synthes recommends using a new sterile burr for each operation. This prevents health risks to the patient.
- Used burrs present the following risks:
 - Necrosis due to excess heat
 - Longer cutting time due to reduced performance of the burr

Precautions:

- **Burrs must be cooled with irrigation liquid to prevent heat necrosis.**
- **The size of the burr attachment must correspond to the size of the burr (e.g. attachment size S with burr size S) or one burr size bigger (e.g. attachment size S with burr size M).**
- **User and OR personal must wear safety goggles when working with burrs.**
- **When the Burr Attachments are not attached to the handpiece during tool change, use the Handhold (05.001.074) for easier change of burrs.**

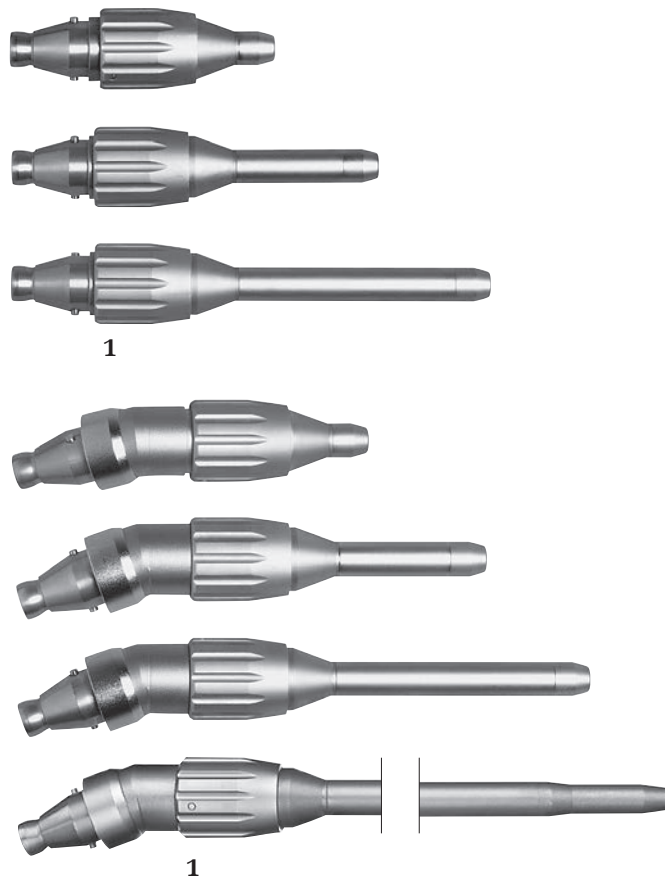

1 Release sleeve for burrs

**Drill/Burr Attachment, Straight,
for Round Shafts \varnothing 2.35 mm (05.001.123)**

Gear ratio 1:1



**Drill/Burr Attachment, Straight,
for Round Shafts \varnothing 2.35 mm (05.001.128)**

Gear ratio 16:1

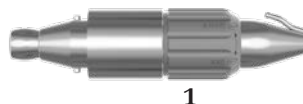

Friction fit attachment for 2.35 mm diameter shafts with round shaft, J-latch and Mini-quick coupling.

Changing cutting tools

1. Lock unit.
2. Turn the release sleeve (1) until it engages in the UNLOCK position and remove the tool.
3. Insert the new tool and turn the release sleeve into the LOCK position until it engages.

Precautions:

- The user is liable for the safety and correct application of the Synthes Power Tool including the attachment and the cutting tools. In particular consider the following points:
 - maximum speed of the Drill/Burr Attachment for round shafts with 2.35 mm diameter is 60,000 rpm for 05.001.123 and 3,750 rpm for 05.001.128.
 - the use of appropriate cutting tools (specifically length and speed)
 - the secure fixation of the cutting tool, i.e. the tool must be fully inserted
 - the instrument must be rotating before contact is made with the workpiece
 - avoid jamming and using the instrument as a lever as this leads to an increased risk of breakage
- Check the vibration and the stability of the used cutting tool before every usage on the patient. If vibration or instability occur, reduce the speed until there is no vibration anymore or do not use the burr.

Adapter for Intra Coupling

Adapter for Intra Coupling (05.001.103)

Gear ratio 1:1



The Adapter for Intra Coupling (05.001.103) enables the use of dental handpieces, mucotomes and dermatomes designed according to ISO 3964 (EN 23 964) in combination with the Electric Pen Drive (05.001.010) and Air Pen Drive (05.001.080).

Warranty/Liability: The user is responsible to ensure the compatibility of products used in combination with the Electric- and Air Pen Drive System and the Adapter for Intra Coupling.

Attachments

Perforators



Perforator (05.001.054)

Gear reduction: 97:1

The perforator is used with the related trepan burrs (03.000.350–03.000.351) including the protective sleeves (05.001.096–03.001.097) to open a cranium with a thickness of 3 mm or above. The handpiece has to be in the FWD  position. Hold the perforator perpendicular to the skull at point of penetration and always apply constant pressure when the trepan burr is engaged in the bone. As soon as the cranium is cut through, the trepan burr automatically disengages.



Changing trepan burrs

1. Turn the release sleeve for trepan burrs (1) until the locking pin (2) disengages from the locking groove (3). (Position , Fig. 1).
2. Pull off the trepan burr together with the protective sleeve.
3. Insert a new trepan burr into the protective sleeve and make sure that the pins on the trepan burr engage properly in the grooves in the protective sleeve.
4. Place the new trepan burr together with the protective sleeve on the perforator.
5. Turn the release sleeve for trepan burrs (1) until the locking pin (2) engages in the locking groove (3). (Position , Fig. 2).

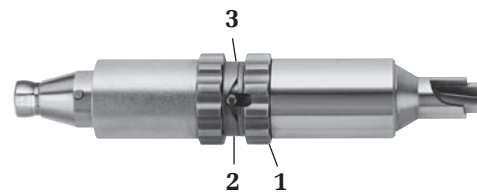

- 1 Release sleeve for trepan burrs
2 Locking pin
3 Locking groove

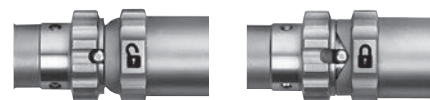

Fig. 1

Fig. 2

Precautions:

- If conditions such as adherent dura, intracranial pressure or other underlying abnormalities are present in the area of the penetration, the perforator may cut the dura. Caution must be observed when perforating thin skull areas such as temporal bone, infants, children, elderly, or diseased bone since skull consistencies and thicknesses can vary and the dura could be cut. Only use the perforator 05.001.054, the trepan burrs 03.000.350–03.000.351 and the protective sleeves 05.001.096–05.001.097 on bones with a thickness of 3 mm or above.
- It is recommended to cool the trepan burr during trepanation (use the irrigation nozzle 05.001.076).
- Check function before each use of the perforator.

Perforator with Hudson Coupling (05.001.177)

Gear reduction: 97:1

The Perforator with Hudson coupling is used with a trepan burr/protection sleeve combination – usually referred to as a cranial perforator – with a Hudson end to open the cranium. The operational mode of the hand piece has to be FWD . Hold the perforator perpendicular to the skull at the point of penetration and always apply constant pressure when the trepan burr is engaged in the bone.

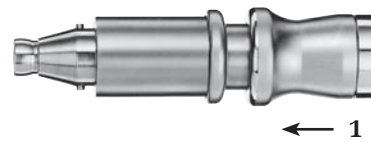

1 Coupling sleeve

Changing the cranial perforator

1. Attaching the cranial perforator:

First move the coupling sleeve (1) on the adapter toward the rear, and then completely insert the tool.

After the tool has been fully inserted, release the coupling sleeve. Check that the tool is properly locked in the attachment by gently pulling on it.

2. Removing the cranial perforator:

First move the coupling sleeve (1) towards the rear, and then remove the tool.

Precautions:

- For the use of the trepan burrs or cranial perforators the respective instructions for use with warnings and restrictions of the supplier is valid.
- It is recommended cooling the cutting tool during trepanation to avoid heat necrosis. Use the irrigation nozzle 05.001.180. Make sure that the irrigation nozzle is placed in a way that the cooling liquid reaches the tool.
- Check function before each use of the perforator.
- The user is liable for the surgical application.
- The user is liable to check the compatibility of the Perforator with Hudson Coupling, the Irrigation Nozzle and the cutting tool used.

Craniotome Attachment

Craniotome Attachment (05.001.059) and Dura Guards (05.001.051–05.001.053)

Gear ratio: 1:1

The system includes a Craniotome Attachment and Dura Guards in 3 lengths (S, M, L). The related burrs are also marked with S, M and L.



Changing cranial burrs

1. Lock the handpiece.
2. Turn the release sleeve for burrs (1) until it engages in the UNLOCK position.
3. Pull off the Dura Guard over the burr and remove the burr.
4. Insert the new burr as far as possible turning it slightly. The burr is correctly inserted when the Dura Guard can be properly fitted.
5. Push the Dura Guard over the burr and mount the Dura Guard on the Craniotome Attachment (pay attention to the arrows for the correct inserting position (2)). Then turn the release sleeve of the Craniotome Attachment into the LOCK position until it engages to clamp the burr and the Dura Guard.
6. Check that the Cranial Burr can be turned freely and that the Dura Guard is well engaged by pulling on it slightly.



1 Release sleeve for burrs and Dura Guard

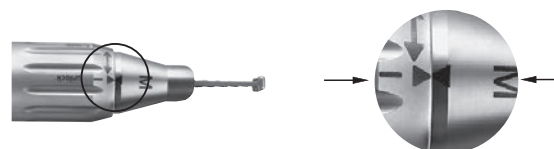

2 Arrows indicating the proper inserting position

Precautions:

- Only use the Craniotomes with the related Cranial Burrs.
- Cranial Burrs must be cooled with irrigation liquid to avoid heat necrosis to the nozzle built into the Dura Guard.
- Avoid side load on the burr and Dura Guard in order to prevent breakage of the Dura Guard.
- When the Craniotome Attachment is not attached to the handpiece during tool change, use the Handhold (05.001.074) for easier change of the burr and Dura Guard.

Cutting Tools

General Information

Intended use

Saw blades

The saw blades are designed for use in traumatology and orthopaedic surgery of the skeleton, e.g. cutting bone.

Stainless steel burrs

Stainless Steel Burrs (Small Torx Cutting Tools) are designed for the use in surgery of the skeleton, i.e. cutting, shaping, smoothing, drilling, reaming or burring of bones.

Diamond coated or carbide burrs

Diamond coated or carbide burrs (Small Torx Cutting Tools) are designed for the use in surgery of the skeleton, i.e. cutting, shaping, smoothing of bones, teeth and metal.

Single Use/Reprocessing

For best results Synthes recommends using a new cutting tool for each operation. Performing cuts with a new and sharp cutting tool is faster, more precise and generates less heat development. This results in a shorter surgery time, a reduction of risk of bone necrosis and a better, reproducible result.

All diamond coated or carbide cutting tools are single use only.

Packaging and Sterility

All cutting tools are available sterile packed.

The manufacturer cannot guarantee sterility if the package seal is broken or if the package is improperly opened, and assumes no liability in such instances.

Dimension

Cutting tool dimension is enclosed within the packaging label.

Cooling of Cutting Tools

Synthes strongly recommends the use of cooling fluid to cool cutting tools.

Implant Removal with Cutting Tools

Implant removal with cutting tools should only be conducted if no other solution for implant removal exists. Only use diamond coated or carbide cutting tools. Remove all particles by continuous flushing and vacuuming. Soft tissue must be covered well. Observe the material composition of the implant.

User Safety

User and OR personal must wear safety goggles.

Disposal of the Cutting Tools

Only dispose contaminated cutting Tools within contaminated hospital waste or decontaminate it.

For further information regarding cutting tools refer to the Instructions for Use "Synthes Cutting Tools" (60121204).

For cleaning and sterilization of cutting tools refer to "Clinical Processing of Cutting Tools" (036.000.499) for detailed clinical processing instructions.

For an overview and the ordering information of all cutting tools available refer to the brochure "Small Bone Cutting Tools" (DSEM/PWT/1014/0044).

Care and Maintenance

General Information

Power tools and attachments are frequently exposed to high mechanical loads and shocks during use and should not be expected to last indefinitely. Proper handling and maintenance help extend the useful life of surgical instruments. Frequent reprocessing does not have a great effect on the life of the unit and attachments.

Gentle care and maintenance with proper lubrication can substantially increase the reliability and life of the system components.

Synthes power tools must be serviced and inspected annually by the original manufacturer or an authorized site. The manufacturer assumes no warranty for damages arising from improper use, neglected or unauthorized servicing of the tool.

For more information about Care and Maintenance, please refer to the Air Pen Drive Care and Maintenance Poster (DSEM/PWT/0415/0065).

Precautions:

- **Reprocessing must be performed immediately after each use.**
- **Cannulations, unlocking sleeves and other narrow sites require special attention during cleaning.**
- **Cleaners with a pH 7–9.5 are recommended. The use of cleaners with higher pH-values can – depending on the cleaner – cause a dissolution of the surface of aluminum and its alloys, plastics or compound materials, they should only be used considering the data regarding material compatibility according to its data sheet. At pH values higher than 11 also the surfaces of stainless steel can be affected. For detailed information about material compatibility, see "Material Compatibility of Synthes Instruments in Clinical Processing" at <http://emea.depuySynthes.com/hcp/reprocessing-care-maintenance>**
- **Follow the enzymatic cleaner or detergent manufacturer's instructions for use for correct dilution concentration, temperature, exposure time and water quality. If temperature and time are not provided, follow Synthes recommendations. Devices should be cleaned in a fresh, newly made solution.**
- **Detergents used on the products will contact the following materials: stainless steel, aluminum, plastic, and rubber seals.**
- **Do not immerse any system component in aqueous solutions or in an ultrasonic bath. Do not use**

pressurized water as this will cause damage to the system.

- **Synthes recommends using new sterile cutting tools for each operation. Refer to "Clinical Processing of Cutting Tools" (036.000.499) for detailed clinical processing instructions.**
- **Lubricating regularly with Synthes Maintenance Unit (05.001.099), the Maintenance Spray (05.001.098) or Synthes Maintenance Oil (05.001.095), especially when automated cleaning is performed, will reduce wear and can substantially extend the service life of the product.**

Unusual Transmissible Pathogens

Surgical patients identified as at-risk for Creutzfeldt-Jakob disease (CJD) and related infections should be treated with single-use instruments. Dispose of instruments used or suspected of use on a patient with CJD after surgery and/or follow current national recommendations.

Notes:

- **The clinical processing instructions provided have been validated by Synthes for preparing a non-sterile Synthes medical device; this instruction is provided in accordance with ISO 17664 and ANSI/AAMI ST81.**
- **Consult national regulations and guidelines for additional information. Compliance is additionally required with internal hospital policies and procedures and recommendations of manufacturers of detergents, disinfectants, and any clinical processing equipment.**
- **Cleaning Agent Information: Synthes used the following cleaning agents during validation of these reprocessing recommendations. These cleaning agents are not listed in preference to other available cleaning agents which may perform satisfactorily – neutral pH enzymatic detergents (e.g. Steris Prolystica 2X Concentrate Enzymatic Cleaner).**
- **It remains in the responsibility of the processor to ensure that the processing performed achieves the desired result using the appropriate properly installed, maintained and validated equipment, materials and personnel in the processing unit. Any deviation by the processor from the instructions provided should be properly evaluated for effectiveness and potential adverse consequences.**

Care and Maintenance

Cleaning and Disinfection

Preparation Prior to Reprocessing

Disassembly

Before cleaning, remove all the instruments, cutting tools, attachments and cables from the power tool.

Important:

- Clean all movable parts in opened or unlocked position.
- Make sure that no cleaning solution enters the air inlet of the handpiece as well as the inside of the hose (Figs. 3–5).
- When cleaning the handpiece, do not insert objects into the air inlet and outlet holes since this would damage the micro filter.
- Make sure that the release sleeve of the handpiece is free from residues and can move properly (Fig. 6).
- Do not automatically clean or sterilize the foot switch (05.001.081).

Cleaning and Disinfection of the Foot Switch

1. To clean the foot switch, wipe it off with a clean, soft and lint-free cloth dampened with deionized water and dry it.
 2. To disinfect the foot switch, wipe it off with a clean, soft and lint-free cloth dampened with a minimum of 70% alcohol-based disinfectant for thirty (30) seconds. A disinfectant that is VAH listed, EPA registered or locally recognized is recommended. This step has to be repeated two (2) additional times using a new, clean, soft and lint-free cloth dampened with a minimum 70% alcohol-based disinfectant each time. Follow the instructions provided by the manufacturer of the disinfectant.
- The foot switch may be cleaned under running water if necessary. Make sure that no water enters the ventilation hole on the bottom plate and into the 3 plugs in the back. Do not immerse. Allow to dry after cleaning.

Cleaning and Disinfection of Handpieces, Air Hoses and Attachments

Handpieces, Air Hoses and Attachments may be processed using manual cleaning or automated cleaning with manual pre-cleaning.

Assembly prior to manual and automated cleaning:

- Put the Protective Cap (05.001.086) on the handpiece (05.001.080), (Fig. 1).
- Connect both sides of the Air Hose (05.001.083, 05.001.084) with the Seal Nipple for Double Air Hose for Air Pen Drive (05.001.091), (Fig. 2).
- Seal the Synthes Double Air Hose (519.510, 519.530 or



Fig. 1: Pen with Protective Cap



Fig. 2: Seal Nipple for Double Air Hose for Air Pen Drive



Fig. 3: Hose couplings



Fig. 4: Air in-take



Fig. 5: Air in-take



Fig. 6: Release sleeve

- 519.550) air hoses by joining the inlet and outlet.
- Connect both sides of the Dräger Double Air Hose (519.610, 519.630 or 519.650) with the Seal Nipple (519.596) and both sides of the BOC/Schrader Air Hose (519.511 or 519.531) with the Seal Nipple (519.591 or 519.592).

Make sure that the surfaces, which the Protective Cap, Seal Nipple and hose couplings will cover, are disinfected. To do this, wipe off these surfaces with a clean, soft and lint-free cloth dampened with a minimum of 70% alcohol-based disinfectant. Make sure that no disinfectant enters the hose and the handpiece.

Manual Cleaning Instructions

Important:

- Follow the instructions from chapter "Preparation Prior To Cleaning" before starting the manual cleaning.
- Do not clean the foot switch following the Manual Cleaning Instructions.

1. **Remove debris.** Rinse the device under running cold tap water for a minimum of 2 minutes. Use a sponge, soft lint-free cloth or soft-bristled brush to assist in removing gross soil. For cannulations of attachments, the cleaning brush (05.001.075) shown below, should be used.

Note: Do not use pointed objects for cleaning. Brushes shall be inspected before daily use and discarded if they have degraded to the point where they may scratch instrument surfaces or be ineffective due to worn or missing bristles.

2. **Manipulate moving parts.** Manipulate all moving parts such as the triggers, sleeves and switches under running tap water to loosen and remove gross debris.
3. **Spray and wipe.** Spray and wipe the device using a neutral pH enzymatic solution for a minimum of 2 minutes. Follow the enzymatic detergent manufacturer's directions for correct temperature, water quality (i.e. pH, hardness) and concentration/dilution.
4. **Rinse with tap water.** Rinse device with cold tap water for a minimum of 2 minutes. Use a syringe or pipette to flush lumens and channels.
5. **Clean with detergent.** Clean the device manually under running warm water using an enzymatic cleaner or detergent for a minimum of 5 minutes. Manipulate all moving parts under running water. Use a soft-bristled brush and/or soft lint-free cloth to remove all visible soil and debris.

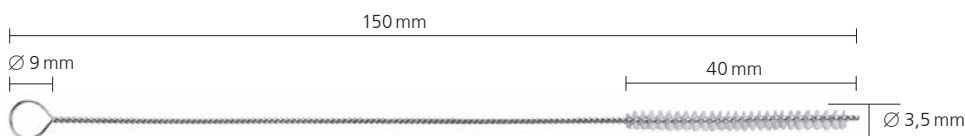

Cleaning Brush (05.001.075)

Follow the enzymatic cleaner or detergent manufacturer's instructions for use for correct temperature, water quality and concentration/dilution.

6. **Rinse with tap water.** Rinse the device thoroughly using cool to lukewarm running water for a minimum of 2 minutes. Use a syringe, pipette or water jet to flush lumens and channels. Actuate joints, handles and other movable device features in order to rinse thoroughly under running water.
7. **Wipe/Spray disinfection.** Wipe off or spray the surfaces of the devices with a minimum of 70% alcohol-based disinfectant.
8. **Visually inspect device.** Inspect the cannulations, coupling sleeves, etc. for visible soil. Repeat steps 1–8 until no visible soil remains.
9. **Final rinse with de-ionized/purified water.** Final rinse with de-ionized or purified water for a minimum of 2 minutes.
10. **Dry.** Dry device using a soft lint-free cloth or medical grade compressed air. If smaller devices or cannulations contain residual water, blow dry with medical grade compressed air.



Automated Cleaning Instructions with Manual Pre-cleaning

Important:

- Follow the instructions from chapter "Preparation Prior To Cleaning" before starting the automated cleaning with manual pre-cleaning.
- Manual pre-cleaning prior to automated cleaning/disinfection is important to ensure that cannulations and other difficult to access areas are clean.
- Alternative cleaning/disinfection procedures other than in the procedure described below (including manual pre-cleaning) have not been validated by Synthes.
- Do not clean the foot switch following the Automated Cleaning Instructions with Manual Pre-cleaning.

1. **Remove debris.** Rinse the device under running cold tap water for a minimum of 2 minutes. Use a sponge, soft lint-free cloth or soft-bristled brush to assist in removing gross soil. For cannulations of the handpiece and attachments, the cleaning brush (05.001.075 shown below) should be used.

Note: Do not use pointed objects for cleaning. Brushes shall be inspected before daily use and discarded if they have degraded to the point where they may scratch instrument surfaces or be ineffective due to worn or missing bristles.

2. **Manipulate moving parts.** Manipulate all moving parts such as the triggers, sleeves and switches under running tap water to loosen and remove gross debris.
3. **Spray and wipe.** Spray and wipe the device using a neutral pH enzymatic solution for a minimum of 2 minutes. Follow the enzymatic detergent manufacturer's directions for correct temperature, water quality (i.e. pH, hardness) and concentration/dilution.

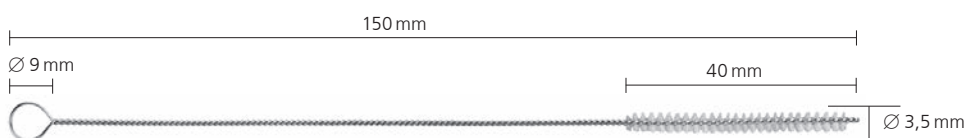

Cleaning Brush (05.001.075)

4. **Rinse with tap water.** Rinse device with cold tap water for a minimum of 2 minutes. Use a syringe or pipette to flush lumens and channels.
5. **Clean with detergent.** Clean the device manually under running warm water using an enzymatic cleaner or detergent for a minimum of 5 minutes. Manipulate all moving parts under running water. Use a soft-bristled brush and/or soft lint-free cloth to remove all visible soil and debris. Follow the enzymatic cleaner or detergent manufacturer's instructions for use for the correct temperature, water quality and concentration/dilution.
6. **Rinse with tap water.** Rinse the device thoroughly using cool to lukewarm running water for a minimum of 2 minutes. Use a syringe, pipette or water jet to flush lumens and channels. Actuate joints, handles and other movable device features in order to rinse thoroughly under running water.
7. **Visually inspect device.** Inspect the cannulations, coupling sleeves, etc. for visible soil. Repeat steps 1–6 until no visible soil remains.
8. **Load washing basket.** Place devices in the specially designed tray for machine washing supplied by Synthes (68.001.800) as shown on the next page or refer to the loading plan (DSEM/PWT/1116/0126).

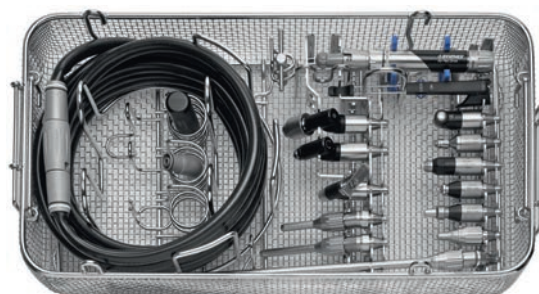

68.001.800

Loading Plan for Air Pen Drive (APD) Washing Basket

68.001.800 Washing Basket, size 1/1, for Electric Pen Drive (EPD) and Air Pen Drive (APD)

+ 68.001.602 Lid for Washing Basket, size 1/1

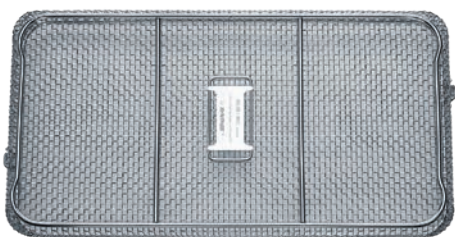
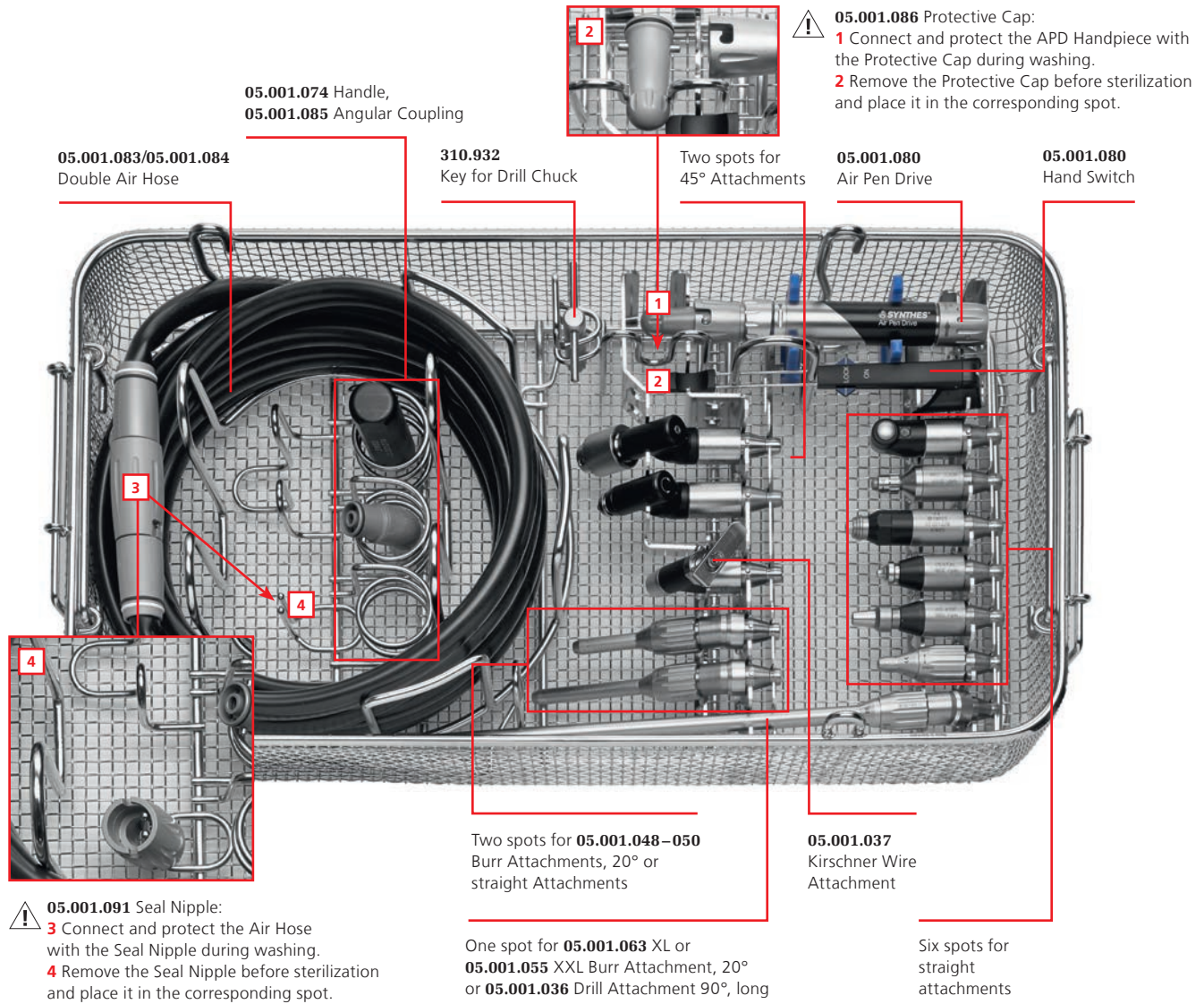

68.001.602
Lid for Washing Basket size 1/1



68.001.800 and **68.001.602**
Dimensions (Length × Width × Height)
Washing Basket w/out Lid: 500 × 250 × 117 mm
Washing Basket with Lid: 504 × 250 × 150 mm

9. Automated cleaning cycle parameters

Note: The washer/disinfector should fulfill the requirements as specified in ISO 15883.

Step	Duration (minimum)	Cleaning instructions
Rinse	2 minutes	Cold tap water
Pre-wash	1 minute	Warm water (≥ 40 °C); use detergent
Cleaning	2 minutes	Warm water (≥ 45 °C); use detergent
Rinse	5 minutes	Rinse with de-ionized (DI) or purified water (PURW)
Thermal disinfection	5 minutes	Hot DI water, ≥ 90 °C
Dry	40 minutes	≥ 90 °C

10. **Inspect the device.** Remove all the devices from the washing basket. Inspect the cannulations, coupling sleeves, etc. for visible soil. If necessary, repeat the manual pre-clean/automated cleaning cycle. Confirm that all parts are completely dry. If smaller devices or cannulations contain residual water, blow dry with medical grade compressed air.

Automated cleaning/disinfection is an additional stress for power equipment, especially for seals and bearings. Therefore, systems must be properly lubricated and regularly sent to be serviced (at least once per year).

Maintenance and Lubrication

To ensure long service life and reduce repairs, it is necessary that the accessible moving parts of the handpiece and attachment are lubricated after each use. Lubrication helps prevent damage and malfunction of the devices.

For further information on lubrication, please refer to the Instruction for Use of the Synthes Maintenance Oil 05.001.095 (60099549), Synthes Maintenance Spray 05.001.098 (60099550) and the APD Care and Maintenance Poster (DSEM/PWT/0415/0065).

Maintenance – using the Synthes Maintenance Unit

Synthes recommends using the Synthes Maintenance Unit (05.001.099) developed for oiling of handpiece and attachments. With the Maintenance Unit an optimal maintenance of the system over the entire service life can be ensured. The operation of the Maintenance Unit is explained in the related Instructions for Use (DSEM/PWT/0914/0027).

For attaching the Air Pen Drive to the Maintenance Unit, the Adapter for Maintenance Unit for Air Pen Drive 05.001.089, has to be used. The pen must be on position foot switch during oiling.

It is recommended that Synthes Maintenance Oil (05.001.095) for Electric and Air Pen Drive is being applied after each use or as required, on movable parts of the handpiece, as described in the following chapter entitled "Maintenance – manually".

Precaution: The Air Pen Drive has to be oiled through the air in-/outlet, not through the front.



Maintenance Unit,
05.001.099



Adapter for Maintenance Unit,
for Air Pen Drive 05.001.089

Maintenance – manually

Oiling the handpiece – with Maintenance Spray 05.001.098

1. Perform maintenance on the handpiece following every use with the Synthes Maintenance Spray (05.001.098) and Oiling Adapter for Air Pen Drive (05.001.092). The pen must be on foot switch position.
2. Push the spray over the air in-take part and briefly actuate it once (approx. 1 sec.). When doing so, wrap the adapter for Air Pen Drive (05.001.092) with a cloth to catch excess oil, or hold it over a washbasin. Always spray away from the body.
3. Remove the excess oil with a cloth after spraying.

It is recommended to apply Synthes Maintenance Oil 05.001.095 for Electric and Air Pen Drive after each use or when needed, on movable parts on the handpiece as described in the following chapter entitled "Maintenance of movable parts on handpiece and Foot Switch – with Synthes Maintenance Oil (05.001.095)".

Oiling the attachments

4. Perform maintenance on the attachments following every use with the Synthes Maintenance Spray (05.001.098) and oiling Adapter for Attachments for Maintenance Spray (05.001.102).
5. Push the spray over the attachment coupling and briefly actuate it once (approx. 1 sec.). When doing so, wrap the attachments with a cloth to catch excess oil, or hold over a washbasin. Always spray away from the body.
6. Remove the excess oil with a cloth after spraying.



Maintenance of movable parts on handpiece and Foot Switch – with Synthes Maintenance Oil (05.001.095)

Apply Synthes Maintenance Oil 05.001.095 for Electric and Air Pen Drive after each use or when needed, on movable parts on the handpiece and the Foot Switch.

Oiling movable parts of the handpiece

Apply one drop of oil in the slots between the adjustment sleeve **1** and the basic body, one drop of oil in the slots behind the release sleeve **2** and move the sleeves. To oil the valve **3** of the handpiece first set the handpiece on Hand Switch position. Then drop one drop of oil on the valve and connect the Hand Switch to the handpiece. Operate the Hand Switch by moving it up and down. Make sure that the valve opens and closes and that oil get into the valve. If necessary, repeat the oiling procedure. Finish by wiping off excess oil from the handpiece.

Oiling movable parts of the Foot Switch

If the connections for air hoses and irrigation do not move smoothly please drop one drop of Synthes Maintenance Oil 05.001.095 on each connection and move them to spread the oil.

Precaution: Only use the Synthes Maintenance Spray (05.001.098) or/and Synthes Maintenance Oil for Electric and Air Pen Drive (05.001.095). Their biocompatible composition matches the requirements for power tools in the operating room. Lubricants with other compositions may lead to sticking and could have a toxic effect.

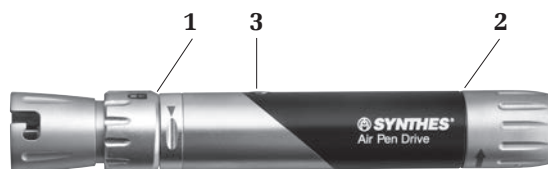

Care and Maintenance

Function Control

- Visually inspect for damage and wear.
- Should the system have corroded parts, do not use it anymore and send it to the Synthes service center.
- Check the handpiece controls for smooth operation and function.
- Check the coupling sleeves of the handpiece and attachments for smooth operation and check for function together with instruments such as cutting tools.
- Check instruments for correct adjustment and functioning prior to every use.

Packaging, Sterilization and Storage

Packaging

Put cleaned, dry products into the proper places in the Synthes Vario Case (68.000.020 or 68.000.030) or in the Washing Basket (68.001.800). Additionally, use an appropriate sterilization wrap or re-usable rigid container system for sterilization, such as a Sterile Barrier System according to ISO 11607. Care should be taken to protect implants, and pointed and sharp instruments from contact with other objects that may damage the surface or the Sterile Barrier System.

Sterilization

Important: Remove the Seal Nipple for Double Air Hose for Air Pen Drive (05.001.091) and the Protective Cap (05.001.086) from the Air Pen Drive before sterilization. Disconnect the Synthes Double Air Hose (519.510, 519.530 or 519.550) before sterilization. Remove the seal nipple (519.596) of the Dräger Double Air Hose (519.610, 519.630 or 519.650) and the seal nipple (519.591 or 519.592) of the BOC/Schrader Air Hose (519.511 or 519.531) before sterilization.

Synthes Air Pen Drive System may be resterilized using validated steam sterilization methods (ISO 17665 or national standards). Synthes' recommendations for packed devices and cases are as follows.

Cycle type	Sterilization exposure time	Sterilization exposure temperature	Drying time
Saturated steam-forced air removal (pre-vacuum, minimum 3 pulses)	Minimum 4 minutes	Minimum 132 °C Maximum 138 °C	20–60 minutes
	Minimum 3 minutes	Minimum 134 °C Maximum 138 °C	20–60 minutes

Dry times generally range from 20 to 60 minutes due to differences in packaging materials (Sterile Barrier System, e.g., wraps or re-usable rigid container systems), steam quality, device materials, total mass, sterilizer performance and varying cool-down time.

Storage

Storage conditions for products labeled "STERILE" are printed on the packaging label. Packaged and sterilized products should be stored in a dry, clean environment, protected from direct sunlight, pests, and extremes of temperature and humidity. Use products in the order in which they are received ("first-in, first-out principle"), taking note of any expiration date on the label.

Precautions:

- **The Foot Switches should not be sterilized.**
- **The following maximum values may not be exceeded: 138°C for a maximum of 18 minutes. Higher values can damage the sterilized products.**
- **After sterilization, the handpiece should only be used again when it has cooled down to room temperature.**
- **Do not accelerate the cooling process.**
- **Hot air, ethylene oxide, plasma and formaldehyde sterilization are not recommended.**

Care and Maintenance

Repairs and Technical Service

The tool should be sent to the Synthes office for repair if it is faulty or malfunctions.

If a device drops, it has to be sent in for service.

Faulty devices may not be used. If it is no longer possible or feasible to repair the tool it should be disposed of, cf. the following chapter "Disposal".

Besides the above mentioned care and maintenance steps no further maintenance work must be carried out independently or by third parties.

This system requires regular maintenance service, at least once a year, in order to maintain its functionality. This service has to be performed by the original manufacturer or an authorized site.

Please use the original packaging to send devices back to Synthes manufacturer or an authorized site.

Warranty/Liability: The manufacturer shall take no responsibility for damage resulting from unauthorized maintenance.

Disposal

In most cases, faulty tools can be repaired (cf. previous chapter "Repairs and Technical Service").

Precaution: Contaminated products have to run through the complete reprocessing procedure, so that there is no danger of infection in case of disposal.

Please send tools that are no longer used to the local Synthes representative. This ensures that they are disposed of in accordance with the national application of the respective directive. The tool may not be disposed of with household waste.

Troubleshooting

Problem	Possible causes	Remedy
Pen does not start up.	Adjustment sleeve on pen is set to LOCK position.	Set adjustment sleeve to HAND or FOOT switch position.
	Release sleeve for burr on burr attachment set to UNLOCK position.	Set release sleeve on burr attachment to LOCK position.
	Hand Switch turned 180°.	Turn Hand Switch 180° and fit as described in the chapter Hand Switch.
	Hand Switch cannot work because Foot Switch is shutting off air supply.	Remove Foot Switch and connect the handpiece directly to the air power supply or use the Foot Switch.
	Adjustment sleeve is in the position HAND or LOCK while trying to work with the Foot Switch.	Set adjustment sleeve to position FOOT.
	Safety switch on Hand Switch is in LOCK position.	Set safety switch to ON position.
Drive has not enough power.	Operating pressure too low.	Set operating pressure on pressure regulator to 6–8 bar.
	Micro filter blocked.	Exchange micro filter in the central air supply.
	Air inlet is blocked.	Remove solid objects from the air inlet with tweezers. Important: Do not use piercing objects to do this. Lock the drive when removing objects.
	Hose is too long.	Check that the entire length of hose does not exceed 8 m.
	Hose couplings defective.	Check wall and drive hose couplings for tightness.
	Central air supply tubes are obstructed.	Check central air supply.

Problem	Possible causes	Remedy
Pen runs at full speed all the time.	Adjustment sleeve is in the position FOOT without having a foot switch attached.	Set adjustment sleeve in position HAND or LOCK.
Attachments cannot be coupled to unit.	Attachment coupling is blocked by deposits.	Remove solid objects with a pair of tweezers. Attention: When removing objects, set unit to OFF.
Attachment or tool (saw blade, drill, burr etc.) cannot be coupled or only with difficulty.	Movable parts have not been maintained.	Oil the movable parts.
Tool (saw blade, drill, burr etc.) cannot be coupled or only with difficulty.	Shaft geometry of tool damaged.	Replace tool or send to your Synthes service office.
Bones and tool heat up due to working process.	Cutting edges of tool are dull.	Replace tool.
	No irrigation has been used.	Use irrigation.

If the recommended remedies are unsuccessful, please contact your Synthes service center.

System Specifications

Technical Data

Pen

Weight:	169 g/5.96 oz
---------	---------------

Length:	144 mm/5.7 in
---------	---------------

Recommended Pressure:	6–8 bar For maximum 10 minutes (continuous operation) it is possible to run the Air Pen Drive up to 12 bar* with the following attachments: 05.001.045–05.001.050, 05.001.054, 05.001.059, 05.001.055.
-----------------------	---

Continuously variable speed:	0–60,000 rpm at 6.5 bar 0–80,000 rpm at 12 bar* (only with 05.001.045–05.001.050, 05.001.054, 05.001.059, 05.001.055)
------------------------------	--

***Note:** In regards to the operating pressure [bar], it is important to follow the instructions provided by the respective wall coupling manufacturer.

Foot Switch

Dimensions:	267 mm × 160 mm × 47 mm
-------------	-------------------------

(bar included 151 mm)





10.5 in × 6.3 in × 1.9 in

(bar included 5.9 in)

Precautions:

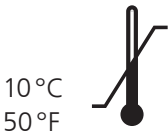
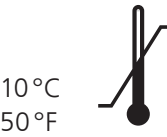
- The Air Pen Drive must never be operated with oxygen, due to danger of explosion. The Air Pen Drive should also not be stored or operated in an explosive atmosphere.
- Dirt inside e.g. adapters, air hoses, angular coupling and pen can cause loss of power.

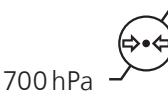
Environmental Conditions

	Operation	Storage
Temperature	10 °C 50 °F  40 °C 104 °F	10 °C 50 °F  40 °C 104 °F
Relative humidity	30%  90%	30%  90%
Atmospheric pressure	700 hPa 0.7 bar  1060 hPa 1.06 bar	700 hPa 0.7 bar  1060 hPa 1.06 bar
Altitude	0–3000 m	0–3000 m

Transportation*

Temperature	Duration	Humidity
–29 °C; –20 °F	72 h	uncontrolled
38 °C; 100 °F	72 h	85 %
60 °C; 140 °F	6 h	30 %

*products have been tested according to ISTA 2A

Duty cycles

To prevent overheating, always respect the duty cycles for each attachment listed below.

Intermittent operation with 6.5 bar	X _{min on}	Y _{min off}	Cycles
Drilling Attachment	5 min	3 min	15 cycles
Burr Attachments	unlimited	–	–
Craniotome Attachment	1 min	30s	5 cycles
Perforation	5 min	3 min	15 cycles
Reciprocating Saw Attachment	3 min	2 min	15 cycles
Oscillating Saw Attachment	1 min	2 min	15 cycles
Sagittal Saw Attachment	1 min	2 min	15 cycles
Intermittent operation with 12 bar*	X _{min on}	Y _{min off}	Cycles
Burr Attachment	10 min	10 min	2 cycles
Craniotome Attachment	1 min	30s	5 cycles
Perforator	3 min	5 min	15 cycles

* For maximum 10 minutes.

These recommendations for times of use for the attachments for Air Pen Drive have been determined under average load with an ambient air temperature of 20°C (68°F).

Above mentioned duty cycles might need to be reduced due to higher loads applied and due to ambient air temperatures above 20°C (68°F). This needs to be taken into consideration during the planning of the surgical intervention.

Generally systems can heat up if in constant use. For this reason the handpiece and the attachment should be allowed to cool down for the above recommended periods of constant use. If this is observed the system will be prevented from overheating and possibly harming the patient or user. After the above indicated number of cycles, the respective attachments must be allowed to cool down for 30 minutes. The user is responsible for the application and for turning off the system as prescribed. If longer periods of constant use are required, an additional handpiece and/or attachment should be used. For oral surgery it is recommended to prevent any contact of warm components with soft tissues as already temperatures around 45°C may damage the lips and oral mucosa.

Precautions:

- **Carefully observe the above recommended duty cycles.**
- **Always use new cutting tools to prevent heating up of the system due to reduced cutting performance.**
- **Careful maintenance of the system will reduce heat development in the handpiece and the attachments. The use of the maintenance unit (05.001.099) is strongly recommended.**

Warning: The Air Pen Drive must not be stored or operated in an explosive atmosphere.

Declaration of the emission sound pressure level and the sound power level according to the EG guideline 2006/42/EG Annex I

Sound pressure level [LpA] in accordance with the norm EN ISO 11202

Sound power level [LwA] in accordance with the norm EN ISO 3746

Handpiece	Attachment	Cutting tool	Sound Pressure Level (LpA) in [dB(A)]	Sound Power Level (LwA) in [dB(A)]	Max. daily exposure time without hearing protection
APD 05.001.080	–	–	78	–	no limitation
	Drill Attachment AO/ASIF 05.001.032	–	76	–	no limitation
	Oscillating Saw Attachment 05.001.038	Saw blade 03.000.313	79	89	no limitation
		Saw blade 03.000.316	78	88	no limitation
	Sagittal Saw Attachments 05.001.039 05.001.182 05.001.183	Saw blade 03.000.303	76	89	no limitation
		Saw blade 03.000.315	81	90	no limitation
	Reciprocating Saw Attachment 05.001.040	Saw blade 03.000.321	80	88	no limitation
		Saw blade 03.000.330	79	88	no limitation
	Burr Attachment 05.001.055	Burr 03.000.017	71	88	no limitation
		Burr	72	89	no limitation

Declaration of vibration emissions according to EU Directive 2002/44/ECVibration emissions [m/s²] according to EN ISO 5349-1.

Handpiece	Attachment	Cutting tool	Declaration [m/s ²]	Max. daily exposure
APD 05.001.080	–	–	< 2.5	8 h
	Drill Attachment AO/ASIF 05.001.032	–	< 2.5	8 h
	Oscillating Saw Attachment 05.001.038	Saw blade 03.000.313	7.8	49 min
		Saw blade 03.000.316	9.7	31 min
	Sagittal Saw Attachments 05.001.039	Saw blade 03.000.303	3.14	5 h 4 min
	05.001.182	Saw blade 03.000.315	16.39	11 min
	05.001.183			
	Reciprocating Saw Attachment 05.001.040	Saw blade 03.000.321	4.1	2 h 58 min
		Saw blade 03.000.330	4.4	2 h 34 min
	Burr Attachment 05.001.055	Burr 03.000.017	0.91	8 h
		Burr 03.000.108	0.64	8 h

Ordering Information

Handpiece

05.001.080	Air Pen Drive 60.000 rpm
------------	--------------------------

Foot Switch

05.001.081	Foot Switch, for Air Pen Drive
------------	--------------------------------

Hand Switch

05.001.082	Hand Switch, for Air Pen Drive
------------	--------------------------------

Hoses and Accessories

05.001.083	Double Air Hose, length 3 m, for Air Pen Drive
05.001.084	Double Air Hose, length 5 m, for Air Pen Drive
05.001.085	Angular Coupling, for Air Pen Drive
05.001.086	Protective Cap, for Air Pen Drive
05.001.087	Adapter for Schrader/Synthes Coupling
05.001.088	Adapter for Dräger/Synthes Coupling
05.001.091	Seal Nipple for Double Air Hose, for Air Pen Drive
519.510	Double Air Hose, length 3 m, for System Synthes
519.530	Double Air Hose, length 5 m, for System Synthes
519.550	Double Spiral Air Hose, up to 2 m, for System Synthes
519.610	Double Air Hose, length 3 m, for System Dräger
519.630	Double Air Hose, length 5 m, for System Dräger
519.650	Double Spiral Air Hose, up to 2 m, for System Dräger
519.511	Double Air Hose, length 3 m, for System BOC/Schrader
519.531	Double Air Hose, length 5 m, for System BOC/Schrader
519.591	Seal Nipple for BOC/Schrader Double Air Hoses, silver
519.592	Seal Nipple for BOC/Schrader Double Air Hoses, beige
519.596	Seal Nipple for Compact Air Drive and for Dräger Double Air Hoses
519.950	Exhaust Air Diffuser
520.501	Wall Coupling with Opposite Tubes*
520.601	Wall Coupling with Parallel Tubes*

Screw Attachments

05.001.028	Screw Attachment, with AO/ASIF Quick Coupling, for EPD and APD
05.001.029	Screw Attachment with Hexagonal Coupling, for EPD and APD
05.001.034	Screw Attachment with Mini Quick Coupling, for EPD and APD

Drill Attachments

05.001.030	Drill Attachment with Mini Quick Coupling, for EPD and APD
05.001.031	Drill Attachment with J-Latch Coupling, for EPD and APD
05.001.032	AO/ASIF Drill Attachment, for EPD and APD
05.001.033	Oscillating Drill Attachment 45°, with Mini Quick Coupling, for EPD and APD
05.001.035	Drill Attachment 90°, short, with Mini Quick Coupling, for EPD and APD
05.001.036	Drill Attachment 90°, long, with Mini Quick Coupling, for EPD and APD
05.001.037	Kirschner Wire Attachment, for EPD and APD
05.001.044	AO/ASIF Drill Attachment 45°, for EPD and APD
05.001.120	Drill Attachment 45°, cannulated, with Jacobs Chuck, for EPD and APD

Ordering Information

05.001.103	Adapter for Intra Coupling, for EPD and APD	05.001.076	Irrigation Nozzle, for Perforator No. 05.001.054
Drill/Burr Attachments		05.001.180	Irrigation Nozzle, for Perforator with Hudson Coupling 05.001.177
005.001.123	Drill/Burr Attachment, straight, for Round Shafts \varnothing 2.35 mm, for EPD and APD	05.001.178.015	Irrigation Tube Set, for EPD and APD, sterile, single pack
05.001.128	Drill/Burr Attachment, straight, for Round Shafts \varnothing 2.35 mm, for EPD and APD	05.001.098	Synthes Maintenance Spray, 400 ml
Saw Attachments		05.001.099	Maintenance Unit
05.001.038	Oscillating Saw Attachment, for EPD and APD	05.001.094	Refill Set for Maintenance Unit
05.001.039	Sagittal Saw Attachment, for EPD and APD	05.001.095	Synthes Maintenance Oil, 40 ml
05.001.183	Sagittal Saw Attachment, centered, for EPD and APD	05.001.092	Adapter for APD Handpiece, for Maintenance Spray No. 05.001.098
05.001.182	Sagittal Saw Attachment, 90°, for EPD and APD	05.001.102	Adapter for EPD/APD Attachments, for Maintenance Spray No. 05.001.098
05.001.040	Reciprocating Saw Attachment, for EPD and APD	05.001.089	Adapter for Maintenance Unit No. 05.001.099, for Air Pen Drive
Burr Attachments		05.001.064	Adapter for Maintenance Unit, for Nos. 05.001.055 and 05.001.063
05.001.045	Burr Attachment, S, for EPD and APD	05.001.074	Handle for Change of Instruments, for EPD/APD Attachments
05.001.046	Burr Attachment, M, for EPD and APD	05.001.075	Cleaning Brush for 05.001.037
05.001.047	Burr Attachment, L, for EPD and APD	310.932	Spare Key for Drill Chuck No 05.001.120
05.001.048	Burr Attachment, S, angled, for EPD and APD	Vario Cases	
05.001.049	Burr Attachment, M, angled, for EPD and APD	68.000.020	Vario Case, size $\frac{1}{4}$, height 88 mm, for Air Pen Drive, without Lid, without Contents
05.001.050	Burr Attachment, L, angled, for EPD and APD	68.000.004	Insert, size $\frac{1}{2}$, for Basic Instruments, for Vario Case No. 68.000.000
05.001.063	Burr Attachment XL, 20°, for EPD and APD	68.000.005	Insert, size $\frac{1}{4}$, for Spine, for Vario Case No. 68.000.000
05.001.055	Burr Attachment XXL, 20°, for EPD and APD	68.000.006	Insert, size $\frac{1}{4}$, for Neuro, for Vario Case No. 68.000.000
05.001.059	Craniotome Attachment, for EPD and APD	689.507	Lid (stainless steel), size $\frac{1}{4}$, for Vario Case
05.001.051	Dura Guard, S, for Craniotome Attachment No. 05.001.059, for EPD and APD	Washing and Sterilization Baskets	
05.001.052	Dura Guard, M, for Craniotome Attachment No. 05.001.059, for EPD and APD	68.001.800	Washing Basket, size $\frac{1}{4}$, for EPD and APD
05.001.053	Dura Guard, L, for Craniotome Attachment No. 05.001.059, for EPD and APD	68.001.602	Lid for Washing Basket, size $\frac{1}{4}$
05.001.054	Perforator, for EPD and APD	Cutting Tools	
05.001.177	Perforator, with Hudson Coupling, for EPD and APD	For ordering informations for the Air Pen Drive Cutting Tools refer to the brochure "Small Bone Cutting Tools" (DSEM/PWT/1014/0044).	
05.001.096	Protection Sleeve for Trepan Burr \varnothing 7.0 mm	* Wall Couplings: The legal manufacturer is Gebrüder Gloor AG Switzerland. The wall couplings are exclusively distributed by Synthes GmbH.	
05.001.097	Protection Sleeve for Trepan Burr \varnothing 12.0 mm	Note: For further information regarding air accessories please contact your local DePuy Synthes representative.	
03.000.350/S	Trepan Burr \varnothing 7.0 mm		
03.000.351/S	Trepan Burr \varnothing 12.0 mm		
Accessories			
05.001.121	Guide for Kirschner Wire, for Oscillating Saw		
05.001.066	Irrigation Nozzle, short, for Nos. 05.001.045 and 05.001.048		
05.001.067	Irrigation Nozzle, medium, for Nos. 05.001.046 and 05.001.049		
05.001.068	Irrigation Nozzle, long, for Nos. 05.001.047 and 05.001.050		
05.001.065	Irrigation Nozzle, for angled Burr Attachment XL No. 05.001.063		
05.001.122	Irrigation Nozzle, for angled Burr Attachment XXL No. 05.001.055		
05.001.111	Irrigation nozzle, for Drill Attachments Nos. 05.001.030, 05.001.031, 05.001.032 and 05.001.110		
05.001.070	Irrigation Nozzle, for Sagittal Saw Attachment No. 05.001.039		
05.001.185	Irrigation Nozzle, for Sagittal Saw Attachment, centered No. 05.001.183		
05.001.184	Irrigation Nozzle, for Sagittal Saw Attachment, 90°, No. 05.001.182		
05.001.071	Irrigation Nozzle, for Reciprocating Saw Attachment No. 05.001.040		



Not all products are currently available in all markets.
Please contact your DePuy Synthes sales representative for
more information.

All Synthes implant instructions for use as well as additional
instructions for use are available as PDF files at www.e-ifu.com

This publication is not intended for distribution in the USA.



Authorised Representative

DePuy Ireland UC
Loughbeg
Ringaskiddy
Co. Cork Ireland